



User Manual

## ***iR-ETN User Manual***

This guide walks through important information about iR-ETN.

AW-10101129\_rev00\_20220307

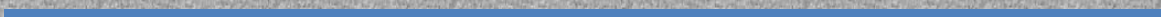

## Table of Contents

1. Product Overview .....	1
1.1 iR-ETN.....	1
2. Specifications.....	2
2.1 iR-ETN.....	2
3. LED Indicators .....	3
3.1 LV LED.....	3
3.2 IO RUN/ERR LED.....	3
3.3 ENET RUN/ERR .....	3
3.4 RJ45 .....	4
4. RJ45 Interface .....	4
5. Reset Button .....	4
6. IP Address Setup .....	4
7. MODBUS Mapping.....	5
7.1 Bit Mapping.....	5
7.2 Register Mapping .....	5
7.3 TCP/IP Register .....	5
7.4 Device Information Register.....	5
7.5 iBus Information Register.....	6
7.6 Module Information Register.....	6
7.7 Module Register .....	6
7.8 Product Code List .....	7
7.9 Special Register .....	7
7.10 Life Guarding Register .....	7
7.11 The Default Value .....	8
7.12 Device Error Code List .....	9
7.13 Reading and Writing iR-PU01-P Objects .....	9
7.14 iR-PU01-P NMT Control Address.....	10
8. In Modbus Mapping .....	11
8.1 iBus Information Register.....	11
8.2 Digital Input Bit Mapping to Modbus .....	12
8.3 Digital Output Bit Mapping to Modbus .....	12
8.4 Analog Input Mapping to Modbus.....	12
8.5 Analog Output Mapping to Modbus.....	12
8.6 Module Register Mapping to Modbus .....	12
8.7 iR-PU01-P Variable Instance Mapping .....	13
9. EtherNet/IP Object .....	15
9.1 Object List .....	15

9.2	Identity Objects.....	15
9.2.1	Service .....	15
9.2.2	Class Attributes .....	15
9.2.3	Instance Attributes.....	15
9.3	Message Router Object.....	16
9.3.1	Class Attributes & Instance Attributes .....	16
9.4	Assembly Object .....	16
9.5	Connection Manager Object.....	16
9.5.1	Class Attributes & Instance Attributes .....	16
9.6	Ethernet Link Object .....	16
9.6.1	Services .....	16
9.6.2	Class Attributes .....	16
9.6.3	Instance Attributes.....	16
9.7	TCP/IP Interface Object .....	17
9.7.1	Service.....	17
9.7.2	Class Attributes .....	17
9.7.3	Instance Attributes.....	17
9.7.4	Interface Status .....	17
9.7.5	Configuration Control.....	18
9.8	Module Register object.....	18
9.8.1	Service.....	18
9.8.2	Class Attribute.....	18
9.8.3	Instance Attributes.....	18
9.9	iBus Object .....	19
9.9.1	Services .....	19
9.9.2	Class Attribute.....	19
9.9.3	Instance Attributes.....	19
9.10	Axis Register Object .....	20
9.10.1	Services .....	20
9.10.2	Class Attributes .....	20
9.10.3	Instance Attributes.....	20
10.	iBus Error Handling .....	21
11.	Power Consumption .....	22
12.	Ethernet Cascading .....	23
13.	EasyRemotelO.....	23
14.	Description File .....	26
14.1	Weintek HMI Tag.....	26
14.2	EtherNet/IP EDS .....	26

14.3	CODESYS PLCopen.XML.....	26
------	--------------------------	----

## 1. Product Overview

### 1.1 iR-ETN

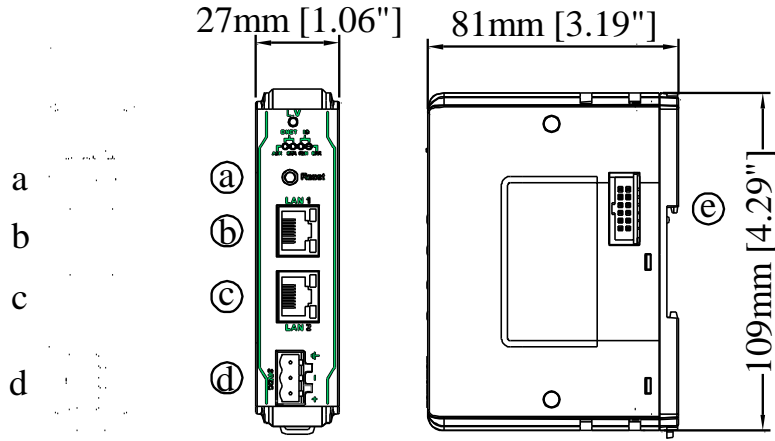

Front View

Side View

<i>a</i>	Reset Button	<i>e</i>	Expansion Connector
<i>b</i>	Ethernet Port LAN 1		
<i>c</i>	Ethernet Port LAN 2		
<i>d</i>	Power Connector		

## 2. Specifications

### 2.1 iR-ETN

Communication Interface Specifications		
<b>Model</b>	iR-ETN	
<b>Expansion I/O Module</b>	Number of Bus Terminals	Depends on Power Consumption. Max. allowable number of iR modules is 16.
	Digital Input Point	Max. 256
	Digital Output Point	Max. 128
	Analog Input Channel	Max. 64
	Analog Output Channel	Max. 64
<b>Indicators</b>	ENET ACK (Green)	Device Status Indicator
	ENET ERR (Red)	Device Error Indicator
	L.V (Red )	Low Voltage Status Indicator
	IO RUN (Green)	Module Status Indicator
	IO ERR (Red)	Module Error Indicator
<b>Data Transfer Rate</b>	10/100 Mbps	
<b>Data Transfer Medium</b>	4 x 2 twisted pair copper cable; category 3 (10 Mbps), category 5 (100 Mbps)	
<b>Distance Between Stations</b>	100 m between hub/switch and Bus Coupler or between Bus Coupler and Bus Coupler	
<b>Protocol</b>	Modbus TCP/IP EtherNet/IP Adapter	
<b>Max. Number of TCP/IP Connections</b>	8	
<b>Topology</b>	line or star wiring	
<b>Network to Logic Power Isolation</b>	Yes	
General Specification		
<b>Power</b>	Power Supply	24 VDC (-15%/+20%)
	Power Dissipation	Nominal 100mA @ 24VDC
	Current for-Internal Bus	Max 2A @ 5VDC
	Current Consumption	220mA @ 5VDC
	Electrical Isolation	Logic to Field Power Isolation: Yes
	Back-up Fuse	≤ 1.6A Self-recovery
<b>Specification</b>	PCB Coating	Yes
	Enclosure	Plastic
	Dimensions WxHxD	27 x 109 x 81 mm
	Weight	Approx. 0.15 kg
	Mount	35mm DIN rail mounting
<b>Environment</b>	Protection Structure	IP20
	Storage Temperature	-20° ~ 70°C (-4° ~ 158°F)
	Operating Temperature	0° ~ 55°C (32° ~ 131°F)
	Relative Humidity	10% ~ 90% (non-condensing)
<b>Certification</b>	EMC Immunity	Conforms to EN 55032: 2012+AC: 2013, Class A EN 61000-6-4: 2007+A1:2011 EN 55024: 2010+A1: 2015 EN 61000-6-2:2005

### 3. LED Indicators

#### 3.1 L.V LED

L.V LED state	Description
OFF	24V power normal
Blinking	Detect 24V power
ON	24V power error

\*iR-ETN40R does not have L.V. LED.

#### 3.2 IO RUN/ERR LED

RUN LED	ERR LED	Description
OFF	OFF	Power off or no power
Blinking	OFF	IO initiating
Blinking	ON	IO initiation error
ON	OFF	IO working
ON	Blinking	IO module alarm
ON	ON	IO communication fault
Blinking	Blinking	Exceeding power limit or too many modules

#### 3.3 ENET RUN/ERR

Run LED	Err LED	Description	
		Modbus TCP	EtherNet/IP
OFF	OFF	Power off or no power	
Blinking	OFF	Communicating	Pre-operational mode
ON	OFF	The device is in the OPERATIONAL state	
OFF	ON	Hardware error, communication fault	24V power error or hardware error, communication fault
ON	Blinking	Reset button is triggered	Reset button is triggered or a recoverable error has occurred

ENET Run/ERR indicator can be set to Modbus TCP mode (default) or EtherNet/IP mode. The communication address for Modbus TCP mode is 1013 (0x03F5 in Hex). Communication mode setting: In “Config Data” set 0 to use Modbus TCP mode and 1 to use EtherNet/IP mode.

### 3.4 RJ45

Speed LED	
OFF	Operating as a 10-Mbps connection
Green ON	Operating as a 100-Mbps connection
LINK /ACT LED	
OFF	No communication
Orange Blinking	There is activity on this port

## 4. RJ45 Interface

LAN1



LAN2



RJ-45	Signal Name	Descriptions
1	TD+	Transmit +
2	TD-	Transmit +
3	RD+	Receive +
4	****	
5	****	
6	RD-	Receive -
7	****	
8	****	
Case	Shield	

## 5. Reset Button

Press and hold the reset button for more than 2 seconds after the unit starts running properly, and wait until ENET ERR LED blinks. The default parameters are shown below, the settings will take effect after cold reset.

Item	Description	Default
1	IP Address	192.168.0.212
2	Netmask	255.255.255.0

## 6. IP Address Setup

Network parameters can be configured using EasyRemote IO, and factory defaults can be restored by pressing the Reset Button. Please see Chapter 13 in this user manual for more information.

Item	Description	Default
1	IP Address	192.168.0.212
2	Netmask	255.255.255.0



## 7. MODBUS Mapping

### 7.1 Bit Mapping

Parameter	Start address		Read/Write	Function Code
	Dec	Hex		
Digital Input	0~511	0000~01FF	Read	2
Digital Output	0~511	0000~01FF	Read	1
			Write	5,15

### 7.2 Register Mapping

Parameter	Start address		Read/Write	Function Code
	Dec	Hex		
Analog Input	0~255	0000~00FF	Read	3,4,23
Analog Output	256~511	0100~01FF	Read	3,23
			Write	6,16,23
Digital Input	800~863	0320~035F	Read	3,23
Digital Output	864~927	0360~039F	Read	3,23
			Write	6,16,23
Registers	-----		Read	3,4,23
	-----		Write	6,16,23

### 7.3 TCP/IP Register

Address		Read/Write	Data Size	Description
Dec	Hex			
1000	03E8	Read	3word	(MAC-address).Ethernet physical address If 00-0C-26-01-02-03, then 0x000C, 0x2601, 0x0203.
1003	03EB	Read/Write	2word	IP address if 192.168.0.212, then 0xC0A8, 0x00D4.
1005	03ED	Read/Write	2word	subnet mask if 255.255.255.0, then 0xFFFF, 0xFF00
1011	03F3	Read	1word	Number of TCP/IP connections

\*TCP/IP Register Settings will take effect after cold reset or after giving Device Reset Warm command.

### 7.4 Device Information Register

Address		Read/Write	Data size	Description
Dec	Hex			
3000	0BB8	Read	4word	Vendor name string 8 char: "weintek" (ASCII)
3004	0BBC	Read	1word	Product Code of iR-ETN: 0x0702 iR-ETN40R: 0x0A73
3005	0BBD	Read	1word	Firmware revision V1.23.4, 0x1234
3006	0BBE	Read	1word	Hardware revision V1.23.4, 0x1234

3007	0BBF	Read	1word	Power consumption unit mW
3008-3023	0BC0-0BCF	R/W	16word	Product name, default: iR-ETN : "iR-ETN" (ASCII)

## 7.5 iBus Information Register

Address		Read/Write	Data size	Description
Dec	Hex			
10000	2710	Read	1word	Slot 0 iR-ETN Product code
10001	2711	Read	1word	Slot 1 Module Product code
10001~10016	2712~2720	Read	1word	Slot 2~Slot 16 Module Product code
10033	2731	Read	1word	Number of modules
10035	2733	Read	1word	Number of points of Digital Input
10036	2734	Read	1word	Number of points Digital Output
10037	2735	Read	1word	Number of Analog channels of Input register
10038	2736	Read	1word	Number of Analog channels of Output register
10045	273D	Read/Write	1word	0: ibus stops when one of the modules is disconnected. 1: ibus continues running when one of the modules is disconnected.

## 7.6 Module Information Register

The data size of the information register of each module is 100word. If the first module starts from address 30000 to 30099, then the second module starts from address 30100 to 30199, and so on.

Address		Read/Write	Data size	Description
Dec	Hex			
30000~30099	7530~7594	Read	100word	Module information of Slot 1
30100~31599	7535~7B6F	Read	100word	Module information of Slot 2~16

Ex: Module information of slot 1

Address		Read/Write	Data size	Description
Dec	Hex			
30000	7530	Read	1word	Module product code, please see Product Code List.
30001	7531	Read	1word	Module firmware version V1.23.4, value 0x1234
30002	7532	Read	1word	Module hardware version V1.23.4, value 0x1234
30003	7533	Read	1word	Power consumption unit mW
30038	7556	Read	1word	Number of points of Digital Input
30039	7557	Read	1word	Number of points Digital Output
30040	7558	Read	1word	Number of Analog channels of module
30041	7559	Read	1word	Number of Analog channels of module

## 7.7 Module Register

Each module has its own parameters; please see the corresponding manual of the

module used. The maximum total data size of the registers is 500word. If the first module starts from address 20000 to 20499, then the second module starts from address 20500 to 20999, and so on.

Address		Read/Write	Data size	Description
Dec	Hex			
20000 ~20499	4E20~ 5013	Read	500word	Module information of Slot 1
20500 ~27999	5014~ 6D5F	Read	500word	Module information of Slot 2~16

## 7.8 Product Code List

Item	Product	Code
1	iR-DI16-K	0154h
2	iR-DM16-P	0351h
3	iR-DQ16-P	0251h
4	iR-DM16-N	0352h
5	iR-DQ16-N	0252h
6	iR-DQ08-R	0243h
7	iR-AQ04-VI	0525h
8	iR-AI04-VI	0425h
9	iR-AM06-VI	0635h
10	iR-AI04-TR	0426h
11	iR-ETN	0702h
12	iR-ETN40R	0A73h

## 7.9 Special Register

Address		Read/Write	Data size	Description
Dec	Hex			
1013	03F5	Read/Write	1word	Indicator Mode: 0: Modbus TCP 1: EtherNet IP
5000	1388	Read	1word	Device Error code
5001	1389	Read	1word	Reserved
5002	138A	Read	1word	Slot1~16 of Module disconnect
5100~ 5612	13EC~ 15EC	Read/Write	512word	Setting the time filter (digital input, unit: ms). The time filter is disabled when it is set to less than 5ms. The time filter remains at 1000ms when it is set to longer than 1000ms. (digital input 0-511)
6000	1770	Write	1word	Device Command 0x5269 : Reset iBus 0x5250 : Parameter to default without TCP/IP 0x5257 : Device Reset Warm

## 7.10 Life Guarding Register

If the communication was missing for longer than the Life Guarding Time, a Life Guard Event is indicated. The output behavior is determined by whether Error Mode

is enabled or disabled. Enabling Error Mode will output an Error Value when an event occurs. Disabling Error Mode will keep the last value (for both digital and analog).

Address		Read/Write	Data size	Description	
Dec	Hex				
6100	17D4	Read/Write	1word	Life Guarding Time, unit: ms, 0: Disabled	
6101	17D5	Read/Write	1word	Digital Output Error Mode (bit15-0)	0:Keep last value 1:Error value
6102	17D6	Read/Write	1word	Digital Output Error Mode (bit31-16)	
.....	.....	.....	.....	.....	
6132	17F4	Read/Write	1word	Digital Output Error Mode (bit511-495)	0: Off 1: On
6133	17F5	Read/Write	1word	Digital Output Error Value (bit15-0)	
6134	17F6	Read/Write	1word	Digital Output Error Value (bit31-16)	
.....	.....	.....	.....	.....	
6164	1814	Read/Write	1word	Digital Output Error Value (bit511-495)	
6165	1815	Read/Write	1word	Analog Output Error Mode (channel 15-0)	0:Keep last value 1:Error value
6166	1816	Read/Write	1word	Analog Output Error Mode (channel 31-16)	
6167	1817	Read/Write	1word	Analog Output Error Mode (channel 47-32)	
6168	1818	Read/Write	1word	Analog Output Error Mode (channel 63-48)	
6169~ 6232	1819~ 1858	Read/Write	64word	Analog Output Error Value (channel 63-0)	-32768~32768

### 7.11 The Default Value

Address		Read/Write	Data size	Description	Default
Dec	Hex				
3008- 3023	0BC0- 0BCF	Read/Write	16word	Product name	"iR-ETN"or "iR-ETN4OR"
5100~ 5612	13EC~ 15EC	Read/Write	512word	Setting the time filter (Digital input 0-511)	0
6100	17D4	Read/Write	1word	Life Guarding Time	0
6101- 6132	17D4- 17F4	Read/Write	32 word	Digital Output Error Mode	0xFF
6133- 6164	17F5- 1814	Read/Write	32 word	Digital Output Error Value	0
6165- 6168	1815- 1818	Read/Write	4word	Analog Output Error Mode	0xFF
6169- 6232	1819~ 1858	Read/Write	64word	Analog Output Error Value	0

※ After pressing [Reset] button, the Default Value will be filled into corresponding registers.

## 7.12 Device Error Code List

Refer to special register address 5000/1388H

Bit Number	Description
Bit0	Low power alarm
Bit1	iBus initialization fault
Bit2	Hardware error
Bit3	Module lost connection
Bit4	Module alarm
Bit5	Number of iBus exceeds 16
Bit6	Power consumption exceeded at iBus system
Bit7~15	Reserved

## 7.13 Reading and Writing iR-PU01-P Objects

Please see iR-PU01-P user manual for more information on index, sub-index, and length.

R/W	Address (Hex)	Description				
Write Object	0xFFF0	Index				
	0xFFF1	Sub-index (High Byte) Length (Low Byte)				
	0xFFF2	Hi Byte	0x56		WORD	DWORD
		Lo Byte	0x78	BYTE		
	0xFFF3	Hi Byte	0x12			
		Lo Byte	0x34			
Sequentially writes data into 0xFFF0~0xFFF3. Data will be sent to iR-PU01-P when written into 0xFFF3.						
Read Object	0xFFF4	Index				
	0xFFF5	Sub-index (High Byte) Length (Low Byte)				
	0xFFF6	Hi Byte	0x56		WORD	DWORD
		Lo Byte	0x78	BYTE		
	0xFFF7	Hi Byte	0x12			
		Lo Byte	0x34			
Step1: Sequentially writes data into 0xFFF4~0xFFF5. Reading iR-PU01-P object starts when data is written into 0xFFF5, and the data will be placed in 0xFFF6~0xFFF7. Step 2: Read data of 0xFFF6~0xFFF7 Object.						

#### 7.14 iR-PU01-P NMT Control Address

NMT Address	State	Value
0xFFF8(65528)	Stop	0x0001
	Operation	0x0002
	Pre-operational	0x0080
	Reset application	0x0081
	Reset communication	0x0082

## 8. In Modbus Mapping

The following is an example showing that when iR-ETN is connected with multiple modules, the address mapping and input/output bit mapping can be as follows:

item	Product
Slot#1	iR-DI16-K
Slot#2	iR-DQ16-P
Slot#3	iR-DM16-P
Slot#4	iR-DQ08-R
Slot#5	iR-AI04-VI
Slot#6	iR-AQ04-VI
Slot#7	iR-PU01-P
Slot#8	iR-PU01-P
Slot#9	iR-PU01-P
Slot#10	iR-PU01-P

### 8.1 iBus Information Register

Address		Description	Value
Dec	Hex		
10000	2710	Slot 0 Product code (Coupler)	0702h (iR-ETN)
10001	2711	Slot 1 Product code (Module)	0x0154 (iR-DI16-K)
10002	2712	Slot 2 Product code (Module)	0x0251 (iR-DQ16-P)
10003	2713	Slot 3 Product code (Module)	0x0351 (iR-DM16-P)
10004	2714	Slot 4 Product code (Module)	0x0243 (iR-DQ08-R)
10005	2714	Slot 5 Product code (Module)	0243h (iR-AI04-VI)
10006	2714	Slot 6 Product code (Module)	0243h (iR-AQ04-VI)
10033	2731	Number of modules	10
10035	2733	Point of Digital Input	24
10036	2734	Point of Digital Output	32
10037	2735	Channels of register input	4
10038	2736	Channels of register output	4

## 8.2 Digital Input Bit Mapping to Modbus

Slot	Module	Bit Offset	Function
		iR-ETN (0000h~0017h)	Code
Slot#1	iR-DI16-K	0000h~000Fh (Digital Input 0~15)	2
Slot#2	iR-DQ16-P	N/A	
Slot#3	iR-DM16-P	0010h~0017h (Digital Input 0~7)	2
Slot#4	iR-DQ08-R	N/A	

## 8.3 Digital Output Bit Mapping to Modbus

Slot	Module	Bit Offset	Function
		iR-ETN (0000h~0020h)	Code
Slot#1	iR-DI16-K	N/A	
Slot#2	iR-DQ16-P	0000h~000Fh (Digital Output 0~15)	5,15
Slot#3	iR-DM16-P	0010h~0017h (Digital Output 0~7)	5,15
Slot#4	iR-DQ08-R	0018h~001Fh (Digital Output 0~7)	5,15

## 8.4 Analog Input Mapping to Modbus

Slot	Module	Description	Address	Function Code
Slot#5	iR-AI04-VI	Channel 0 analog input	0	3, 4, 23
		Channel 1 analog input	1	
		Channel 2 analog input	2	
		Channel 3 analog input	3	

## 8.5 Analog Output Mapping to Modbus

Slot	Module	Description	Address	Function Code
Slot#6	iR-AQ04-VI	Channel 0 analog output	256	6, 16, 23
		Channel 1 analog output	257	
		Channel 2 analog output	258	
		Channel 3 analog output	259	

## 8.6 Module Register Mapping to Modbus

Slot	Module	Description	Modbus Address	Module Register
Slot#5	iR-AI04-VI	Channel 0 Input Mode	22020	20
		Channel 1 Input Mode	22021	21
		Channel 2 Input Mode	22022	22
		Channel 3 Input Mode	22023	23
		.....	.....	.....
Slot#6	iR-AQ04-VI	Channel 0 Output Mode	22500	0
		Channel 1 Output Mode	22501	1
		Channel 2 Output Mode	22502	2



		Channel 3 Output Mode	22503	3
		.....	.....	.....
		16# Error Code	22516	16

### 8.7 iR-PU01-P Variable Instance Mapping

Slot	Module	Description	Address	Function Code
Slot#7 (Axis 0)	iR-PU01-P	Axis 0 variable instance input	40000~40015	23
		Axis 0 variable instance output	40500~40515	
Slot#8 (Axis 1)	iR-PU01-P	Axis 1 variable instance input	40016~40031	23
		Axis 1 variable instance output	40516~40531	
Slot#9 (Axis 2)	iR-PU01-P	Axis 2 variable instance input	40032~40047	23
		Axis 2 variable instance output	40532~40547	
Slot#10 (Axis 3)	iR-PU01-P	Axis 3 variable instance input	40048~40063	23
		Axis 3 variable instance output	40548~40563	

\*The following are examples explaining variable instance mapping. In these examples, Axis 0 is used.

Axis 0 variable instance input:

Item	Address	Description		Data Type		Dec/Hex
1	40000	High Byte	Axis 0 Mode of Operation Display	USINT	Unsigned 8	Dec
		Low Byte	Axis 0 Digital Input	BYTE	Unsigned 8	Hex
2	40001	Axis 0 StatusWord		UINT	Unsigned 16	Hex
3	40002	Axis 0 Position actual value (Lo word)		DINT	Signed 32	Dec
4	40003	Axis 0 Position actual value (Hi word)				
5	40004	Axis 0 Velocity actual value(Lo word)		DINT	Signed 32	Dec
6	40005	Axis 0 Velocity actual value(Hi word)				
7	40006	Axis 0 Position demand internal value(Lo word)		DINT	Signed 32	Dec
8	40007	Axis 0 Position demand internal value(Hi word)				
9	40008	High Byte	Axis 0 Digital Output Status	BYTE	Unsigned 8	Hex
		Low byte	Axis 0 Capture Channel Status	BYTE	Unsigned 8	Hex
10	40009	Axis 0 Error code		UINT	Unsigned 16	Hex
11	40010	Axis 0 2nd additional position actual value (Lo word)		DINT	Signed 32	Dec
12	40011	Axis 0 2nd additional position actual value(Hi word)				
	40012 ~40015	Reserved				

## Axis 0 variable instance output:

Item	Address	Description		Data Type		Dec/Hex
1	40500	High Byte	Axis 0 Mode of Operation	USINT	Unsigned 8	Dec
		Low Byte	Axis 0 Digital Output	BYTE	Unsigned 8	Hex
2	40501	Axis 0 Controlword		UINT	Unsigned 16	Dec
3	40502	Axis 0 Target Position (Lo word)		DINT	Signed 32	Dec
4	40503	Axis 0 Target Position (Hi word)				
5	40504	Axis 0 Profile velocity (Lo word)		DINT	Signed 32	Dec
6	40505	Axis 0 Profile velocity (Hi word)				
7	40506	Axis 0 Target velocity (Lo word)		DINT	Signed 32	Dec
8	40507	Axis 0 Target velocity (Hi word)				
9	40508	Axis 0 Profile acceleration (Lo word)		DINT	Signed 32	Dec
10	40509	Axis 0 Profile acceleration (Hi word)				
11	40510	Axis 0 Profile deceleration(Lo word)		DINT	Signed 32	Dec
12	40511	Axis 0 Profile deceleration (Hi word)				
	40512 ~40515	Reserved				

## 9. EtherNet/IP Object

### 9.1 Object List

Name	Object Type	Object Code (Hex)
Identity	Standard Object	01
Message Router	Standard Object	02
Assembly	Standard Object	04
Connection Manager	Standard Object	06
TCP/IP Interface	Standard Object	F5
Ethernet Link	Standard Object	F6
Module Register	Manufacturer Defined Object	70
iBus Object	Manufacturer Defined Object	71
AXIS Object	Manufacturer Defined Object	80~87

### 9.2 Identity Objects

Class Code: 01HEX

#### 9.2.1 Service

Service Code	Class	Instance	Name	Value
0x01	•	•	Get Attribute All	
0x05	X	•	Reset	0: Reset
0x0E	X	•	Get Attribute Single	

#### 9.2.2 Class Attributes

Instance ID	Attribute ID	Read/Write	Name	Data Type	Value
0	1	Read	Revision	UINT	1
	2	Read	Max Instance	UINT	1
	6	Read	Maximum ID Number Class Attributes	UINT	7
	7	Read	Maximum ID Number Instance Attributes	UINT	7

#### 9.2.3 Instance Attributes

Instance ID	Attribute ID	Read/Write	Name	Data Type	Value	
1	1	Read	Weintek Vendor ID	UINT	1596	
	2	Read	Device Type- Communications Adapter	UINT	12	
	3	Read	iR-ETN Product Code	UINT	1794	
	4	Read	Revision	Major	USINT	1
				Minor	USINT	1
	5	Read	Device State	WORD		
	6	Read	Serial Number	UDINT		
7	Read	Product Name	STRING	"iR-ETN"		

### 9.3 Message Router Object

Class Code: 02<sub>HEX</sub>

#### 9.3.1 Class Attributes & Instance Attributes

None

### 9.4 Assembly Object

Class Code: 04<sub>HEX</sub>

Please refer to the EDS file generated by EasyRemote IO.

### 9.5 Connection Manager Object

Class Code: 06<sub>HEX</sub>

#### 9.5.1 Class Attributes & Instance Attributes

None

### 9.6 Ethernet Link Object

Class Code: F6<sub>HEX</sub>

#### 9.6.1 Services

Service Code	Class	Instance	Name
0x01	•	X	Get Attribute All
0x0E	•	•	Get Attribute Single

#### 9.6.2 Class Attributes

Instance ID	Attribute ID	Read/Write	Name	Data Type	Value
0	1	Read	Revision	UINT	4
	2	Read	Max Instance	UINT	1

#### 9.6.3 Instance Attributes

Instance ID	Attribute ID	Read/Write	Name	Data Type	Value
1	1	Read	Interface Speed	UDINT	100 : Speed 100M
	2	Read	Interface Flags	DWORD	Bit 0 : Link Active Bit 1 : Full Duplex Bit 2~4 : Auto negotiation Bit 5 : Manual Setting required Reset Bit 6 : Local Hardware Fault Others : 0
	3	Read	Physical Address	6 USINTs	MAC address
1	11	Read	Interf Capability Bits	DWORD	Interface capabilities, other than speed/duplex

				Speed/ Duplex Options	USINT	Number of elements
					UINT	Interface Speed
					USINT	Interface Duplex Mode

## 9.7 TCP/IP Interface Object

Class Code: F5<sub>HEX</sub>

### 9.7.1 Service

Service Code	Class	Instance	Name
0x0E	•	•	Get Attribute Single
0x01	X	•	Set Attribute Single

### 9.7.2 Class Attributes

Instance ID	Attribute ID	Read/Write	Name	Data Type	Value
0	1	Read	Revision	UINT	4
	2	Read	Max Instance	UINT	1

### 9.7.3 Instance Attributes

Instance ID	Attribute ID	Read/Write	Name	Data Type	Value
1	1	Read	Interface Status	DWORD	
	2	Read	Configuration Capability	DWORD	0x00000020
	3	Read	Configuration Control	DWORD	0x00000000
	4	Read	Physical Link Path Size of Path	Padded-PATH	00 00 20 F6 24 01
	5	Read	Interface Configuration	UDINT	IP address
				UDINT	Network Mask
				UDINT	Gateway Address
				UDINT	Name Server
				UDINT	Name Server 2
	STRING	Domain Name			
6	Read	Host name	STRING	iR-ETN	
13	Read/Write	Encapsulation Inactivity Timeout	UINT	0 = Disable timeout 1-3600 = timeout in seconds Default = 120	

### 9.7.4 Interface Status

Bit	Name	Definition
0-3	Interface Status	0 = The Interface Configuration attribute has not been



		<p>configured.</p> <p>1 = The Interface Configuration attribute contains configuration obtained from BOOTP, DHCP, or non-volatile storage.</p> <p>2 = The interface configuration attribute contains configuration obtained from hardware settings.</p>
--	--	---

### 9.7.5 Configuration Control

Value	Definition
0	The device shall use statically-assigned IP configuration values..
1	The device shall obtain the interface configuration values via BOOTP.
2	The device shall obtain the interface configuration values via DHCP.

## 9.8 Module Register object

Class Code: 70<sub>HEX</sub>

### 9.8.1 Service

Service Code	Class	Instance	Service Name
0x01	•	X	Set Attribute Single
0x0E	•	•	Get Attribute Single

### 9.8.2 Class Attribute

Instance ID	Attribute ID	Read/Write	Name	Data Type	Value
0	1	Read	Revision	UINT	1

### 9.8.3 Instance Attributes

Instance ID	Attribute ID	Read/Write	Name	Data Type	Value
Slot#	Module Register#	Read/Write	Module Register#	INT	

The following is an example showing the mapping of Instance ID and Attribute ID when iR-ETN is connected to the following modules.

Slot	Module Name
<b>Slot#1</b>	<b>iR-AI04-VI</b>
Slot#2	iR-DQ16-P
Slot#3	iR-DM16-P
Slot#4	iR-DQ08-R
<b>Slot#5</b>	<b>iR-AQ04-VI</b>

Slot	Module	Description	Instance ID	Attribute ID	Module Register
Slot#1	iR-AI04-VI	Channel 0 Input Mode	1	20	20



		Channel 1 Input Mode		21	21
		Channel 2 Input Mode		22	22
		Channel 3 Input Mode		23	23
		.....		.....	.....
Slot#5	iR-AQ04-VI	Channel 0 Output Mode	5	0	0
		Channel 1 Output Mode		1	1
		Channel 2 Output Mode		2	2
		Channel 3 Output Mode		3	3
		.....		.....	.....
		16# Error Code		16	16

For more information on registers, please see the user manual for each module.

### 9.9 iBus Object

Class Code: 71<sub>HEX</sub>

#### 9.9.1 Services

Service Code	Class	Instance	Service Name
0x01	●	X	Set Attribute Single
0x0E	●	●	Get Attribute Single

#### 9.9.2 Class Attribute

Instance ID	Attribute ID	Read/Write	Name	Data Type	Value
0	1	Read	Revision	UINT	1

#### 9.9.3 Instance Attributes

Instance ID	Attribute ID	Read/Write	Name	Data Type	Value
1	0	Read	Module number	UINT	
	1	Read	Digital Input point	UINT	
	2	Read	Digital Output point	UINT	
	3	Read	Analog Input point	UINT	
	4	Read	Axis Point	UINT	
	5	Read	Analog Output point	UINT	
	6	Read	Byte size of Mapping Input Data	UINT	
	7	Read	Mapping Input Data	Struct of Byte	
	8	Read	Byte size of Mapping Output Data	UINT	
	9	Read/Write	Mapping Output Data	Struct of Byte	
	10~25	Read	Module Device Name	String	
	50~65	Read	Module Device Code	UINT	
	90~105	Read	Module Version	UINT	
2	0~255	Read/Write	Digital Input 0~255 filter time	UINT	

3	1	Read/Write	Digital Output Error Mode (bit15-0)	UINT	0: Keep Last Value 1: Incorrect Value
	2	Read/Write	Digital Output Error Mode (bit31-16)	UINT	
	.....	Read/Write	.....	UINT	
	32	Read/Write	Digital Output Error Mode (bit511-495)	UINT	
4	1	Read/Write	Digital Output Error Mode (bit15-0)	UINT	0: Off 1: On
	2	Read/Write	Digital Output Error Mode (bit31-16)	UINT	
	.....	Read/Write	.....	UINT	
	32	Read/Write	Digital Output Error Mode (bit511-495)	UINT	
5	1	Read/Write	Digital Output Error Mode (channel 15-0)	UINT	0: Keep Last Value 1: Incorrect Value
	2	Read/Write	Digital Output Error Mode (channel 31-16)	UINT	
	3	Read/Write	Digital Output Error Mode (channel 47-32)	UINT	
	4	Read/Write	Digital Output Error Mode (channel 63-48)	UINT	
6	1~64	Read/Write	Digital Output Error Mode (channel 0-63)	INT	

## 9.10 Axis Register Object

Class Code: 80<sub>HEX</sub>~87<sub>HEX</sub>

### 9.10.1 Services

Service Code	Class	Instance	Service Name
0x01	●	X	Set Attribute Single
0x0E	●	●	Get Attribute Single

### 9.10.2 Class Attributes

Instance ID	Attribute ID	Read/Write	Name	Data Type	Value
0	1	Read	Revision	UINT	1

### 9.10.3 Instance Attributes

Class ID	Axis Number	01PU Module	
		Index	Sub-index
80hex	Axis1	5500+ Instance ID (Range 5500h-55FFh)	Attribute ID
81hex	Axis2		
82hex	Axis3		
83hex	Axis4		
84hex	Axis1	6000+ Instance ID (Range 6000h-60FFh)	Attribute ID
85hex	Axis2		
86hex	Axis3		
87hex	Axis4		



## 10.iBus Error Handling

When communication with the module is lost, iR-ETN can report an error and stop module communication. The following actions can be taken:

- Set Special Register #10045 (273Dh) to 1 to ignore this error.
- Set Special Register #10045 (273Dh) to 0 to report this error.
- Send Device Command Special Register #6000 (1770h) to reboot iBus.

iBus Error Flowchart:

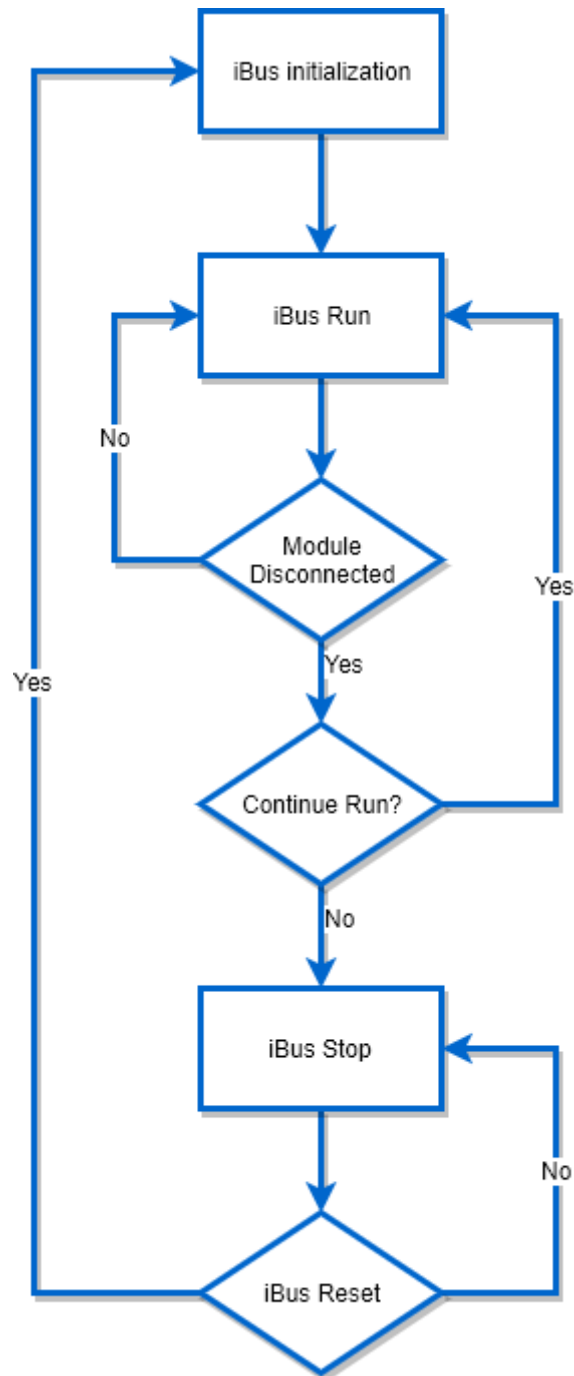

## 11. Power Consumption

Type	Device	Consumption(5V)	Power Supply(5V)
Coupler	iR-ETN	220mA/1.1w	2A/10w
	iR-COP	170mA/0.85w	2A/10w
	iR-ETN40R	526mA/2.63w	2A/10w
Digital I/O	iR-DM16-P	130mA/0.65w	--
	iR-DM16-N	130mA/0.65w	--
	iR-DQ08-R	220mA/1.1w	--
	iR-DQ16-N	205mA/1.02w	--
	iR-DQ16-P	196mA/0.984w	--
	iR-DI16-K	83mA/0.418w	--
Analog I/O	iR-AQ04-VI	65mA/0.325w	--
	iR-AI04-VI	70mA/0.35W	--
	iR-AM06-VI	70mA/0.35W	--
	iR-AI04-TR	65mA/0.325w	--
Motion Control	iR-PU01-P	108mA/0.54W	--

### Note:

The coupler is the only power supply for the modules in this system. Please consider power requirements when connecting multiple modules.

### Example 1:

Device	Name	Consumption	Power Supply
Coupler	iR-ETN	220mA/1.1w	2A/10w
Module	iR-DM16-P *13	130mA*13=1.69A	X
System	Power consumption : 220mA + 1.69A = 1.91 A Power supply: 2A > 1.91A		

### Example 2:

Connecting six iR-DQ08-R, total number of points: 48+16(built-in) = 64 points, output logic: relay

Device	Name	Consumption (2A/5V)
Coupler	iR-ETN40R	526mA
Module	iR-DQ08-R *6	220mA*6=1.32A
System	Power consumption : 0.526A + 1.32A = 1.846 A Power supply: 2A > 1.846A	

### Example 3:

Connecting five iR-DI16-K and five iR-DQ16-P

Total number of Input points: 80+24(built-in) = 104 points

Total number of Output points: 80+16(built-in) = 96 points

Device	Name	Consumption (2A/5V)
Coupler	iR-ETN40R	526mA
Module	iR-DI16-K *5	83mA*5=415mA
	iR-DQ16-P *5	196mA*5= 980mA
System	Power consumption : 526 + 415 + 980 = 1921mA Power supply: 2A > 1.921A	

## 12. Ethernet Cascading

iR-ETN:

- Daisy-chained your Ethernet devices
- Last Ethernet port can be used as a diagnosis port



## 13. EasyRemotelO

EasyRemotelO is an easy-to-use tool for configuring the parameters of iR-ETN. This tool can be found in the installation file of the latest version of EasyBuilder Pro. For more information on EasyRemotelO, please see EasyRemotelO User Manual.

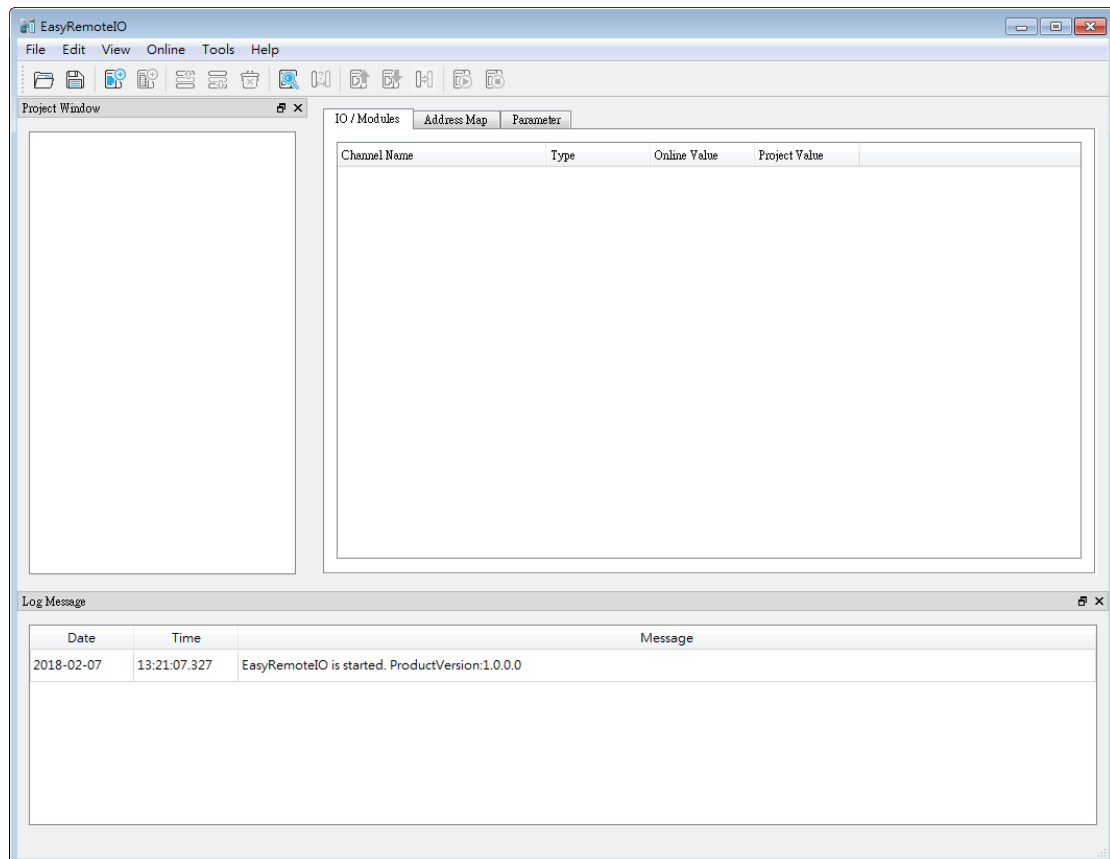

### 1. Preparation:

The default domain of iR-ETN is 192.168.0.212, please set computer's IP to 192.168.0.\*\*.

### 2. Scan iR-ETN:

Select [Online] » [Automatic Scan] or press Shift + S on the keyboard to open the following window to scan the iR-ETN connected with PC.

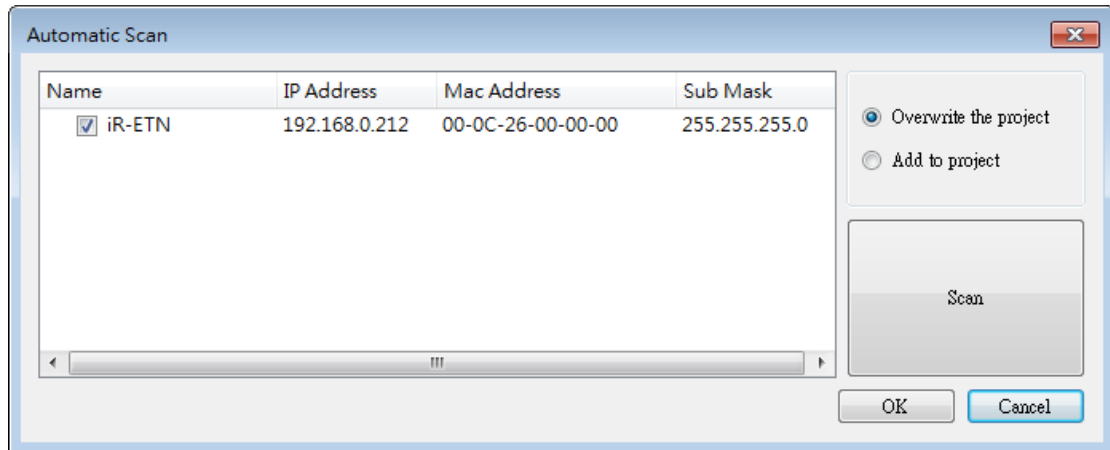

### 3. Change IP to Current Domain:

Select [Online] » [Change IP] to set the iR-ETN's IP address.

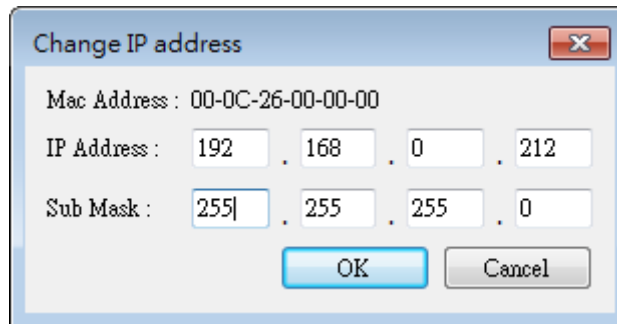

### 4. Check Parameter with Monitor:

Select [Online] » [Start Monitoring] or press Shift + M on the keyboard to activate the connection with iR-ETN. The device status and module status can be viewed via EasyRemoteIO.

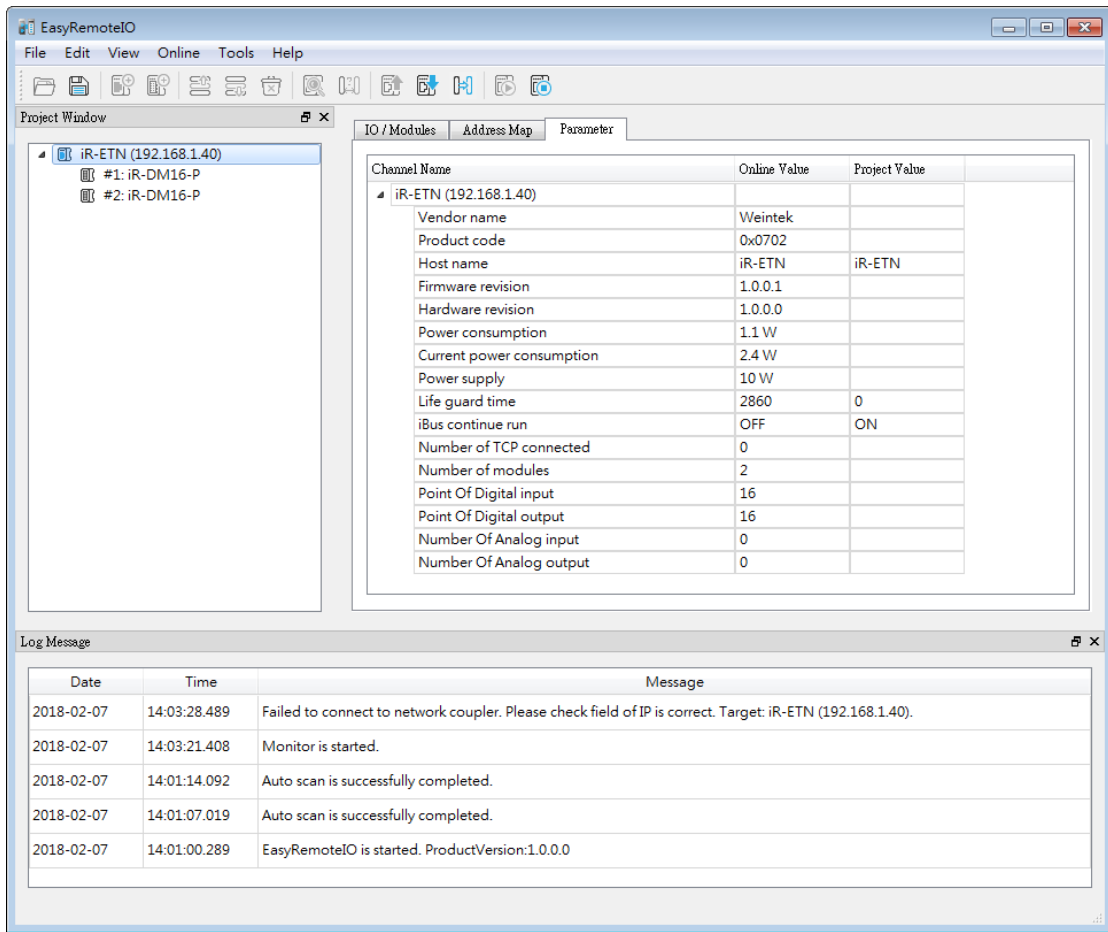

### 5. Export EtherNet/IP EDS file.



## 14. Description File

When using iR-ETN, three types of description files can be generated in EasyRemoteIO.

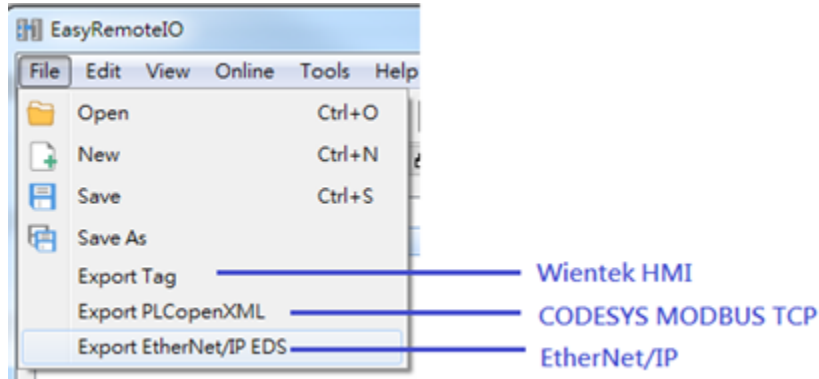

### 14.1 Weintek HMI Tag

The exported tags can be used for Weintek HMI. For more information about exporting tags, see PLC Connection Guide -> Weintek Remote IO (MODBUS TCP/IP).

### 14.2 EtherNet/IP EDS

The corresponding EDS file of the connected module can be exported in the software. The standard EDS file can be used for EtherNet/IP master. For more information about connecting and operating the module, see “iR-ETN EtherNet/IP Connection Guide”.

### 14.3 CODESYS PLCopen.XML

The PLCopen.XML file exported in EasyRemoteIO can be imported in CODESYS.

The import steps:

1. In CODESYS project add Modbus\_TCP\_Master device.
2. Click Modbus\_TCP\_Master, and then select [Project] » [Import PLCopenXML File].

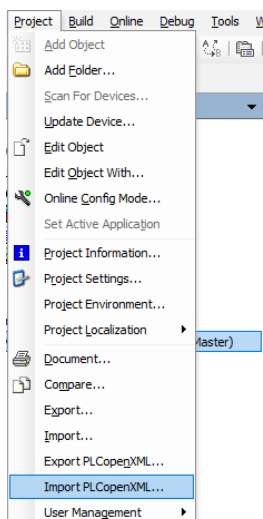

3. After importing the file, the iR-ETN added in CODESYS project can be found.

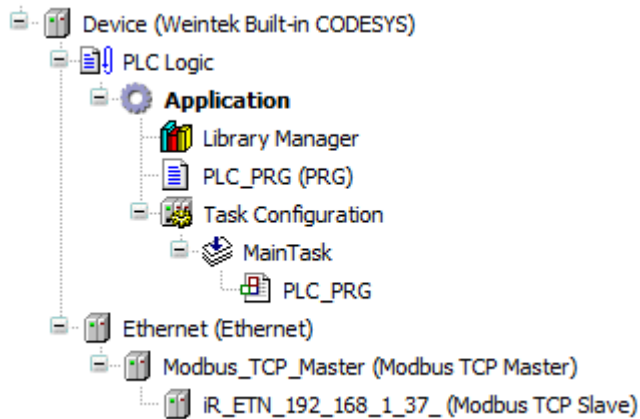

Read/Write channels and initial parameters are built.

General	Name	Access Type	Trigger	READ Offset	Length	Error Handling	WRITE Offset	Length
Modbus Slave Channel	0 I: R-DM16-NL.Digital Input	Read Discrete Inputs (Function Code 02)	Cyclic, t#100ms	16#0000	8	Keep last Value		
	1 I: R-DM16-NL.Digital Output(R)	Read Coils (Function Code 01)	Cyclic, t#100ms	16#0000	8	Keep last Value		
Modbus Slave Init	2 I: R-DM16-NL.Digital Output(W)	Write Multiple Coils (Function Code 15)	Cyclic, t#100ms				16#0000	8
	3 I: R-AQ04-VI.Analog Output	Read/Write Multiple Registers (Function Code 23)	Cyclic, t#100ms	16#0100	4	Keep last Value	16#0100	4
ModbusTCPslave Parameters	4 I: R-DQ16-P.Digital Output(R)	Read Coils (Function Code 01)	Cyclic, t#100ms	16#0008	16	Keep last Value		
	5 I: R-DQ16-P.Digital Output(W)	Write Multiple Coils (Function Code 15)	Cyclic, t#100ms				16#0008	16
ModbusTCPslave I/O Mapping	6 I: R-AI04-VI.Analog Input	Read Input Registers (Function Code 04)	Cyclic, t#100ms	16#0000	4	Keep last Value		
	7 S: R-AI04-TR.Analog Input	Read Input Registers (Function Code 04)	Cyclic, t#100ms	16#0004	4	Keep last Value		
Status								
Information								

General	Line	Access Type	WRITE Offset	Default Value	Length
Modbus Slave Channel	1	Write Single Register (Function Code 06)	16#0x17d4 (=6100)	0	1
	2	Write Single Register (Function Code 06)	16#0x273d (=10045)	0	1
Modbus Slave Init	3	Write Single Register (Function Code 06)	16#0x04b0 (=1200)	0	1
	4	Write Single Register (Function Code 06)	16#0x17d5 (=6101)	65535	1
ModbusTCPslave Parameters	5	Write Single Register (Function Code 06)	16#0x17f5 (=6133)	0	1
	6	Write Single Register (Function Code 06)	16#0x13ec (=5100)	0	1
ModbusTCPslave I/O Mapping	7	Write Single Register (Function Code 06)	16#0x13ed (=5101)	0	1
	8	Write Single Register (Function Code 06)	16#0x13ee (=5102)	0	1
Status	9	Write Single Register (Function Code 06)	16#0x13ef (=5103)	0	1
	10	Write Single Register (Function Code 06)	16#0x13f0 (=5104)	0	1
Information	11	Write Single Register (Function Code 06)	16#0x13f1 (=5105)	0	1