

## 12.1" ~ 21.5" Fanless Panel PC With 6<sup>th</sup> Gen Intel® Core™ i5-6300U Processor



- Projected Capacitive Touch
- Memory and Wi-Fi Kit upgrade available
- IP66 Rated Aluminum Enclosure for Washdown Environments
- Microsoft Windows® 10 IoT OS
- Panel or VESA-100 Mountable

System	CPU	Intel® 6th Gen Core™ i5-6300U CPU processor		
	System Chipset	SoC		
	System Memory Options	1x DDR4 260-pin SO-DIMM 2133MHz RAM (8, 16 GB)		
I/O Ports	USB	2 x USB 3.0 type A		
	Serial	COM1: RS-232/422/485 DE-9P (default RS-232) COM2: RS-232 DE-9P		
	Audio	1 x 3.5 mm line out		
	LAN	2 x GbE RJ-45		
	Power	3-pin connector header, DC power input		
	Remote Power Switch	2-pin connector header		
Expansion	Expansion Slot	Optional Wi-Fi kit (IEEE 802.11a/b/g/n/ac card and antenna)		
Touch Screen	Type	Projected Capacitive Touch		
	Interface	USB		
	Light Transmission	80+%		
Display	Display Type	12.1" SVGA TFT LCD	15" XGA TFT LCD	15.6" HD TFT LCD
	Max. Resolution	800 x 600	1024 x 768	1366 x 768
	Max. Color	16.2 M	16.2 M	16.7 M
	Luminance (cd/m <sup>2</sup> )	450	300	400
	View Angle (H°/V°)	178/178	176/176	170/160
	Contrast Ratio	1500:1	2000:1	500:1
	Backlight Lifetime (hours)	50,000+	70,000+	50,000+
Storage	Solid State Drive Type	1 x 2.5" SATA III, MLC		
	Solid State Drive Capacity Options	64, 128, 256, 512 GB, 1TB SSD		
	SD Card Slot	N/A		
Electrical	Input Voltage	9~36 VDC	9~36 VDC	9~36 VDC
	Input Current	1.31 ~ 5.22 A	1.14 ~ 4.56 A	1.25 ~ 5.0 A
	Input Power (max.)	47 W	41 W	45 W
Mechanical	Dimensions (W x H x D)	12.56 x 9.65 x 2.04 inches [319 x 245 x 51.7 mm]	16.14 x 12.20 x 2.15 inches [410 x 310 x 54.7 mm]	16.22 x 10.94 x 2.32 inches [412 x 278 x 59 mm]
	Net Weight	~ 6.17 lbs [2.8 kg]	~ 9.70 lbs [4.4 kg]	~ 9.92 lbs [4.5 kg]
	Panel Cutout Dimensions (W x H)	11.93 x 9.02" [303 x 229 mm]	15.43 x 11.50" [392 x 292 mm]	15.51 x 10.24" [394 x 260 mm]
	Mounting	Panel mounting, VESA 100 x 100		
	Construction	Silver aluminum front bezel and chassis		
	Environmental	Operating Temperature	32~122°F [0~50°C]	
Storage Temperature		-22~158°F [-30~70°C]		
Relative Humidity		10 to 90% @ 40°C, non-condensing		
Rating		IP66 / NEMA 4 when panel mounted		
Operating System	Certification	cULus / CE / FCC Class A / RoHS		
	Microsoft Windows® Options	Microsoft Windows® 7 Pro for Embedded 64-bit (FES 7 Pro) Microsoft Windows® 10 IoT Enterprise Embedded LTSC 64-bit (EPKEA) Microsoft Windows® 10 IoT Enterprise LTSC 64-bit (PKEA)		
	Linux® Options	Linux® Ubuntu Desktop 22.04		
Notes	Specifications subject to change without notice.			

## 12.1" ~ 21.5" Fanless Panel PC With 6<sup>th</sup> Gen Intel® Core™ i5-6300U Processor



- Projected Capacitive Touch
- Memory and Wi-Fi Kit upgrade available
- IP66 Rated Aluminum Enclosure for Washdown Environments
- Microsoft Windows® 10 IoT OS
- Panel or VESA-100 Mountable

System	CPU	Intel® 6th Gen Core™ i5-6300U CPU processor	
	System Chipset	SoC	
	System Memory Options	1x DDR4 260-pin SO-DIMM 2133MHz RAM (8, 16 GB)	
I/O Ports	USB	2 x USB 3.0 type A	
	Serial	COM1: RS-232/422/485 DE-9P (default RS-232) COM2: RS-232 DE-9P	
	Audio	1 x 3.5 mm line out	
	LAN	2 x GbE RJ-45	
	Power	3-pin connector header, DC power input	
	Remote Power Switch	2-pin connector header	
	Expansion	Expansion Slot	Optional Wi-Fi kit (IEEE 802.11a/b/g/n/ac card and antenna)
Touch Screen	Type	Projected Capacitive Touch	
	Interface	USB	
	Light Transmission	80+%	
Display	Display Type	18.5" HD TFT LCD	21.5" FHD TFT LCD
	Max. Resolution	1366 x 768	1920 x 1080
	Max. Color	16.7 M	16.7 M
	Luminance (cd/m <sup>2</sup> )	300	250
	View Angle (H°/V°)	170/160	178/178
	Contrast Ratio	1000:1	3000:1
	Backlight Lifetime (hours)	50,000+	50,000+
Storage	Solid State Drive Type	1 x 2.5" SATA III, MLC	
	Solid State Drive Capacity Options	64, 128, 256, 512 GB, 1TB SSD	
	SD Card Slot	N/A	
Electrical	Input Voltage	9~36 VDC	9~36 VDC
	Input Current	1.53 ~ 6.11 A	1.50 ~ 6.0 A
	Input Power (max.)	55 W	54 W
Mechanical	Dimensions (W x H x D)	19.67 x 12.39 x 2.57 inches [499.6 x 314.6 x 65.4 mm]	21.94 x 14.26 x 2.56 inches [557.3 x 362.3 x 64.8 mm]
	Net Weight	~ 13.23 lbs. [6 kg]	~ 16.53 lbs. [7.5 kg]
	Panel Cutout Dimensions (W x H)	18.98 x 11.69" [482 x 297 mm]	21.22 x 13.54" [539 x 344 mm]
	Mounting	Panel mounting, VESA 100 x 100	
	Construction	Silver aluminum front bezel and chassis	
Environmental	Operating Temperature	32~122°F [0~50°C]	
	Storage Temperature	-22~158°F [-30~70°C]	
	Relative Humidity	10 to 90% @ 40°C, non-condensing	
	Rating	IP66 / NEMA 4 when panel mounted	
	Certification	cULus / CE / FCC Class A / RoHS	
Operating System	Microsoft Windows® Options	Microsoft Windows® 7 Pro for Embedded 64-bit (FES 7 Pro) Microsoft Windows® 10 IoT Enterprise Embedded LTSC 64-bit (EPKEA) Microsoft Windows® 10 IoT Enterprise LTSC 64-bit (PKEA)	
	Linux® Options	Linux® Ubuntu Desktop 22.04	
Notes	Specifications subject to change without notice.		

## OMI6912BP

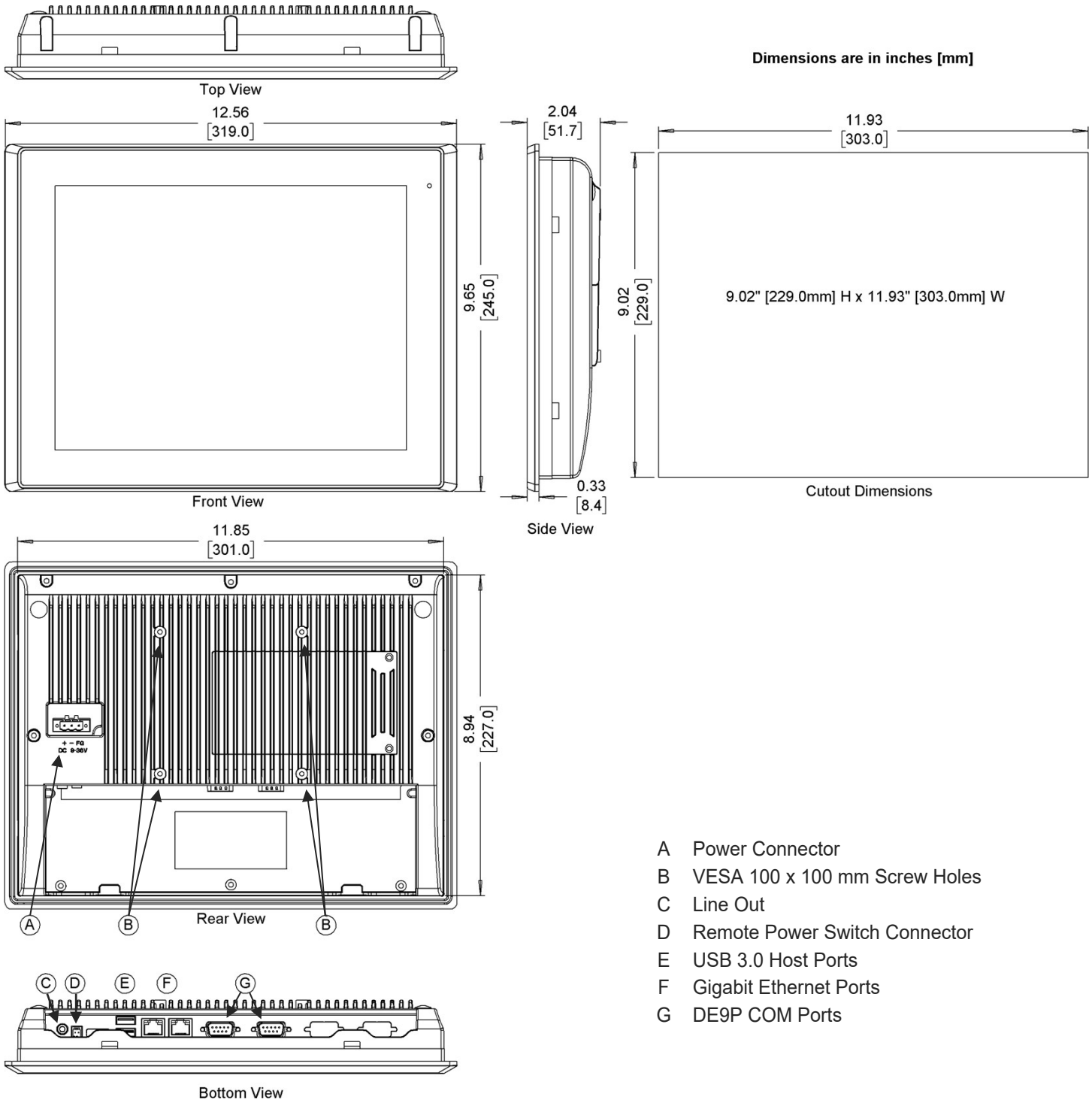

## OMI6915BP

Dimensions are in inches [mm]

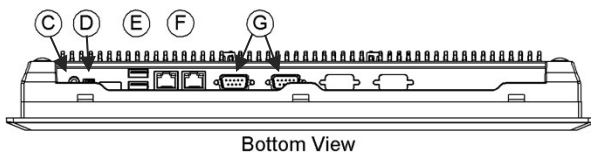
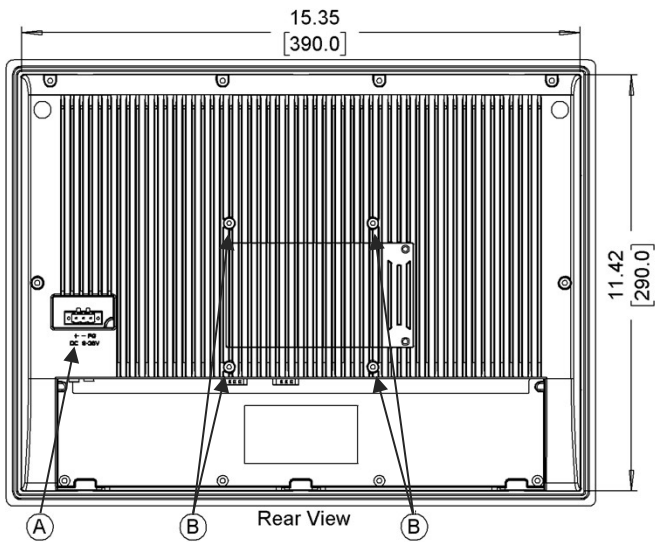
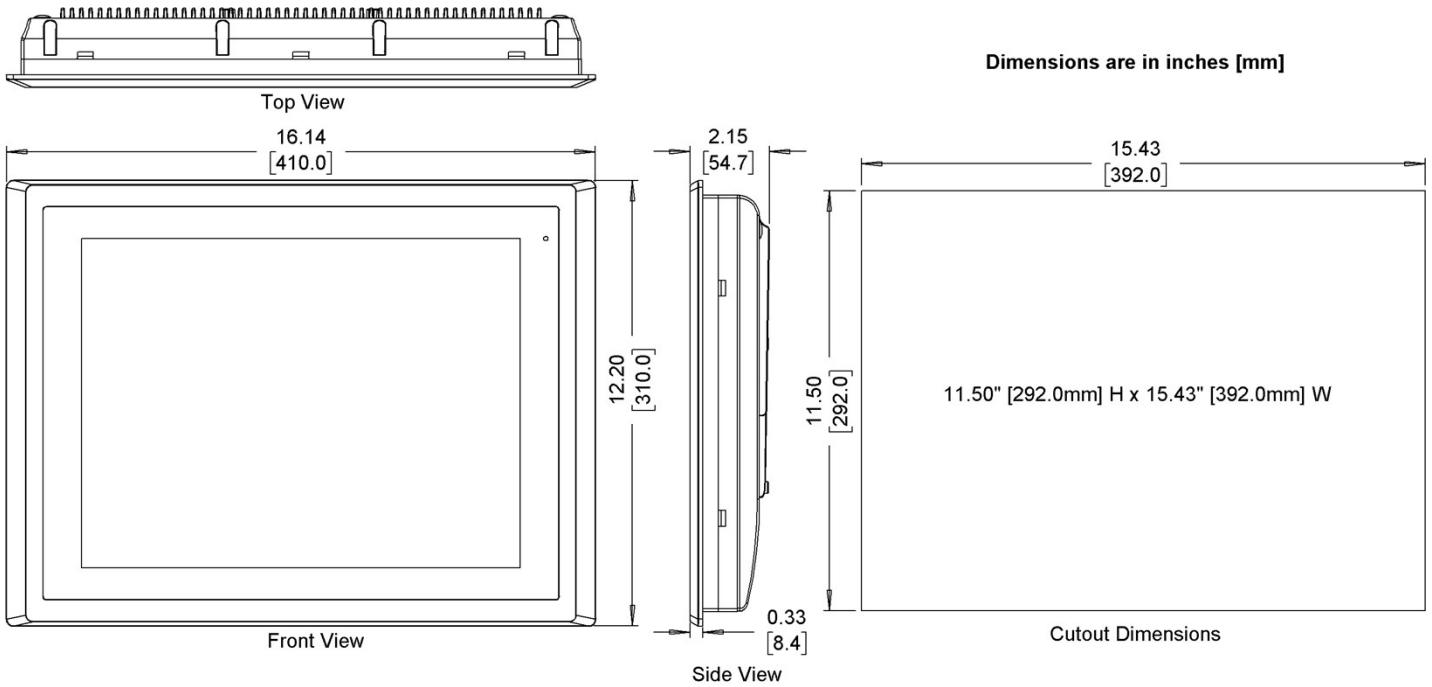

- A Power Connector
- B VESA 100 x 100 mm Screw Holes
- C Line Out
- D Remote Power Switch Connector
- E USB 3.0 Host Ports
- F Gigabit Ethernet Ports
- G DE9P COM Ports

## OMI6916BP

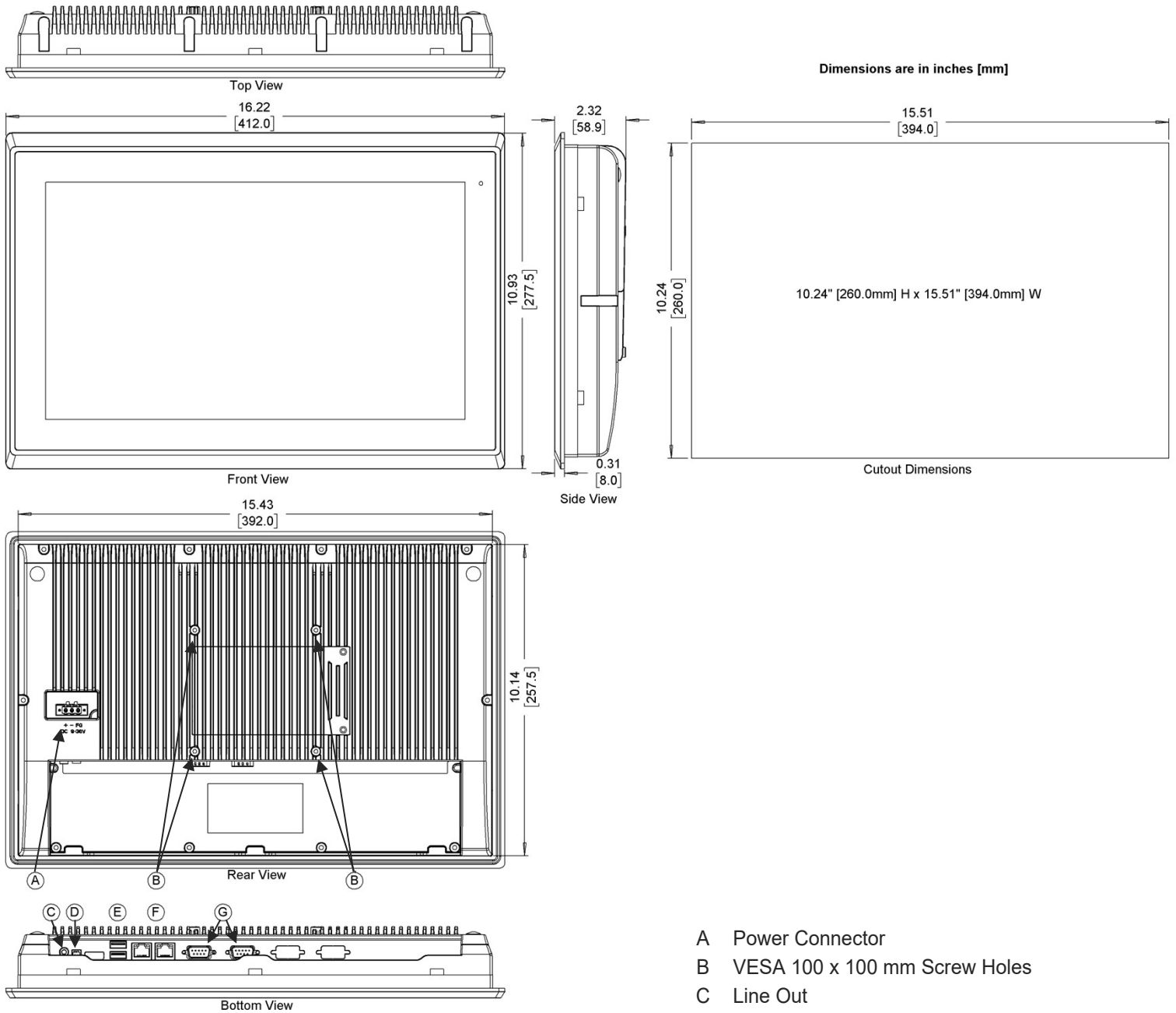

## OMI6918BP

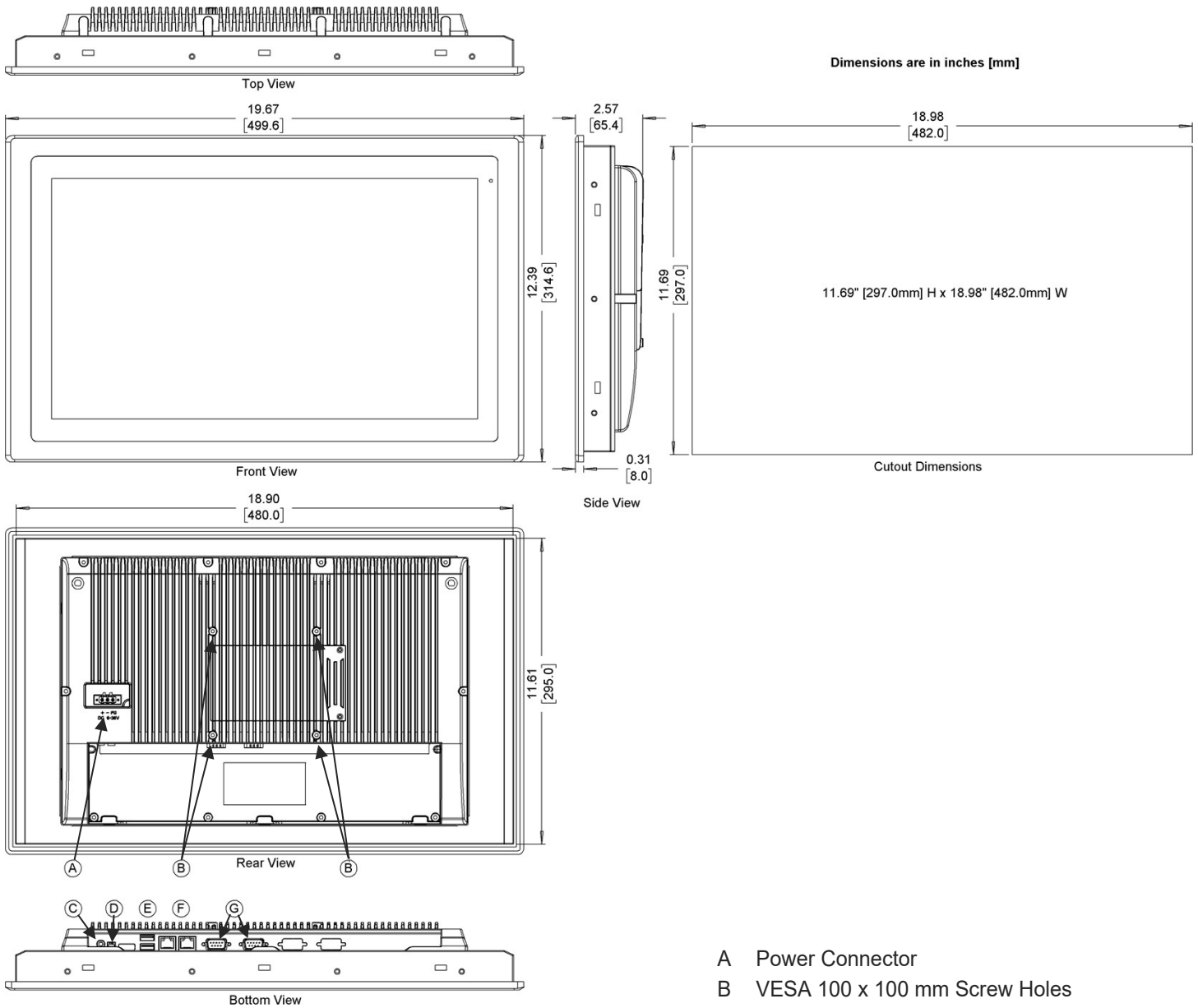

- A Power Connector
- B VESA 100 x 100 mm Screw Holes
- C Line Out
- D Remote Power Switch Connector
- E USB 3.0 Host Ports
- F Gigabit Ethernet Ports
- G DE9P COM Ports

## OMI6921BP

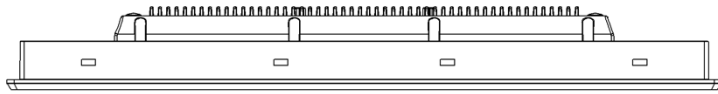

Top View

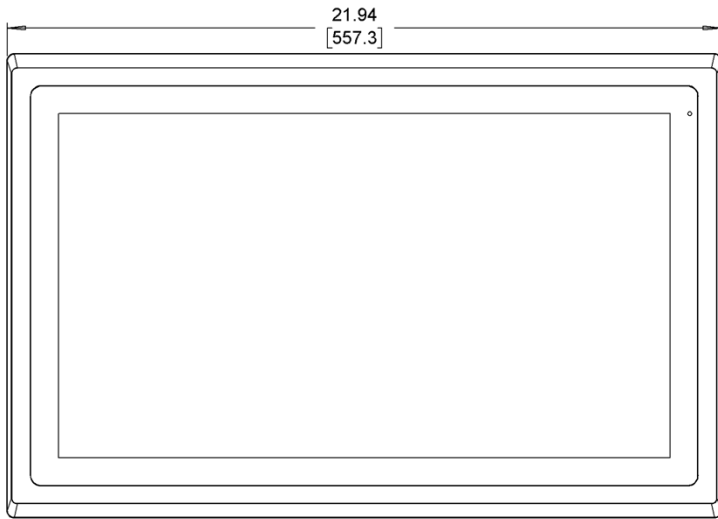

Front View

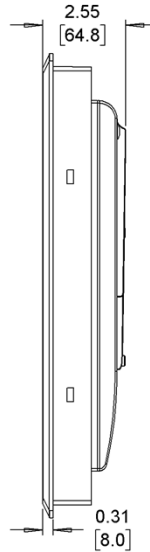

Side View

Dimensions are in inches [mm]

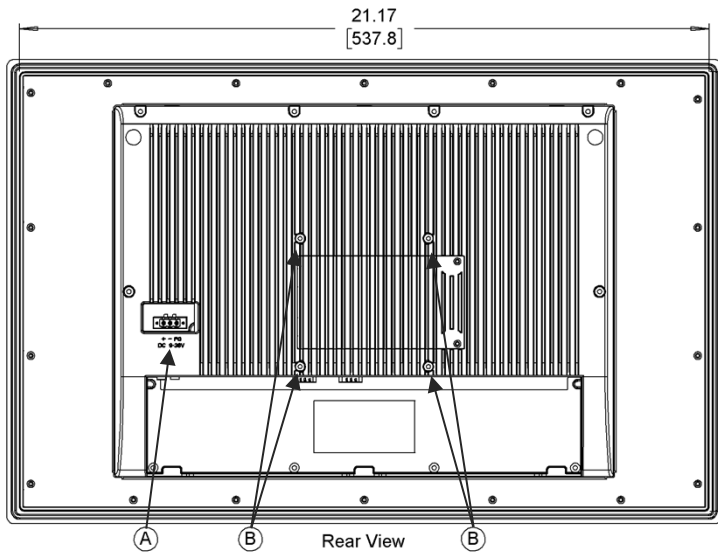

Rear View

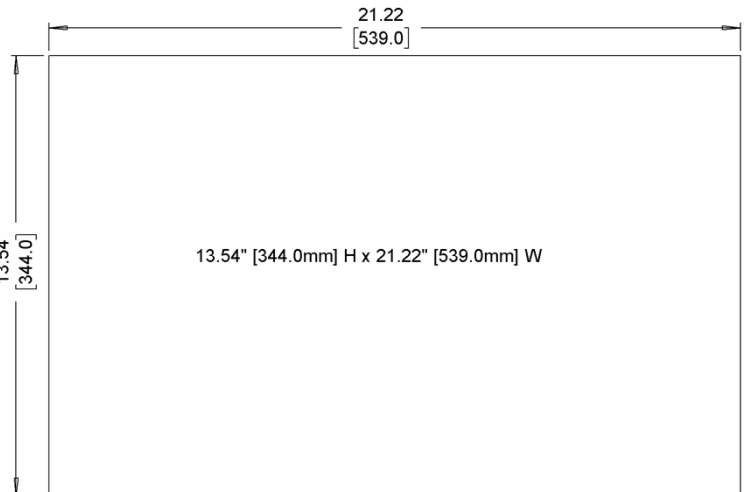

Cutout Dimensions

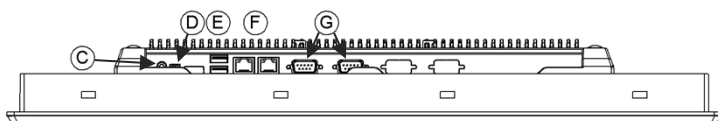

Bottom View

- A Power Connector
- B VESA 100 x 100 mm Screw Holes
- C Line Out
- D Remote Power Switch Connector
- E USB 3.0 Host Ports
- F Gigabit Ethernet Ports
- G DE9P COM Ports



# Why Buy A Maple Industrial PC

In addition to our powerful and affordable hardware, we'll also continue to support your company long after a sale. Wide product selection, large in-stock inventory, outstanding product warranty, free technical support and software, and in-house repairs with quick turnaround times, Maple Systems has your business covered.



## Customize To Meet Your Needs

Companies have chosen Maple Systems solutions over Allen-Bradley, Omron, Siemens, Panasonic, and so many others, in hundreds of applications, in every industry, and in every type of organization. Our Industrial PCs are designed to resolve your toughest automation challenges in manufacturing, processing, and fabrication environments, and because we offer thousands of different configurations, designing your IPC to meet your unique requirements is easy.

All our Industrial PCs are ideal for applications in industrial automation, healthcare, manufacturing, oil & gas, packaging, building automation, water, energy, agriculture, food & beverage, and more. Our offerings include [high brightness/sunlight readable displays](#), [extended temperature IPCs](#), [stainless steel enclosures](#), and [Class I, Div 2 certified IPCs](#). Learn more about the [industries we serve](#) and discover why more and more companies are choosing Maple Systems.

## Supports Your 3rd Party Software

Since our Industrial PCs can be configured with either a Windows™ or [Linux™](#) Operating System, adding your own software is easy. Don't be tied to expensive industrial computers or HMIs just because of a name. Our IPCs support FactoryTalk®, Ignition SCADA®, Emerson Ovation®, Simatic SCADA®, Predator Touch HMI®, and hundreds of other HMI and SCADA software solutions.

We are a proud partner of Award-winning AVEVA™ Edge. This powerful HMI/SCADA software package enables you to create custom industrial control applications for your unique industry, putting you in the driver's seat of creating your industrial process. With easy-to-use commands/tool bars and a Microsoft Windows® programming environment, AVEVA™ Edge's feature-rich application puts you in the driver's seat of creating your industrial process. Learn more about [AVEVA Edge](#).

## Build your SCADA

We offer all the components you need to create your own unique level of supervisory data acquisition and control, from the simplest stand-alone machine to sophisticated multi-device networked production line(s), all the way to enterprise-level operations and IIoT functionalities leveraging cloud connectivity.

Our products can help you standardize communications between devices, gluing different systems together for one source to your SCADA. No need to redesign your entire application. Keep the components that are already working for you, just add Maple Systems components to grow your abilities to supervise, control, and acquire data.



## [Application Story](#)

# Pharmaceutical Equipment

Adding a Maple Systems [Stainless Steel Industrial Panel PC](#) with Wi Fi to an existing machine saved this OEM time and money

This OEM manufacturer uses a Maple Systems Industrial Panel PC for their production-series tablet pressing machines. The rotary tablet press boasts features essential for successful mid-sized tableting without the full-scale price. This application required a cost effective 12" panel touch screen industrial PC with enough computing power for their custom software and reporting system. They also required the front bezel be stainless steel with a IP69K rating to meet washdown sanitization requirements. See how we support the [Pharmaceutical and Medical Industry](#).

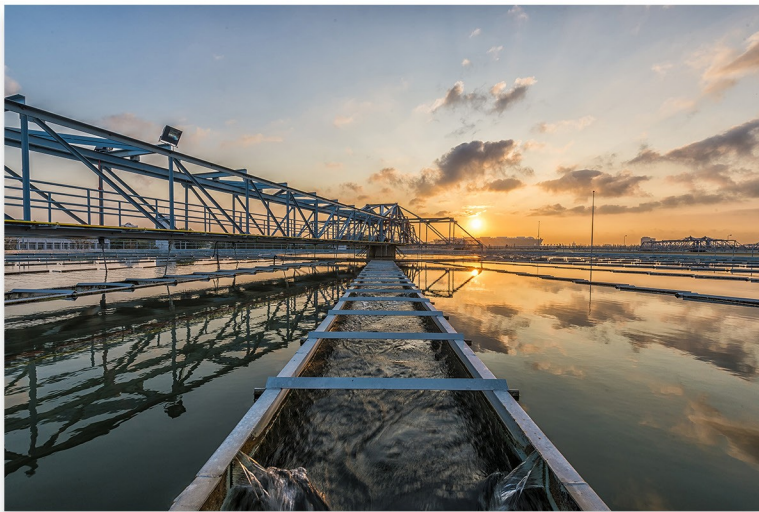
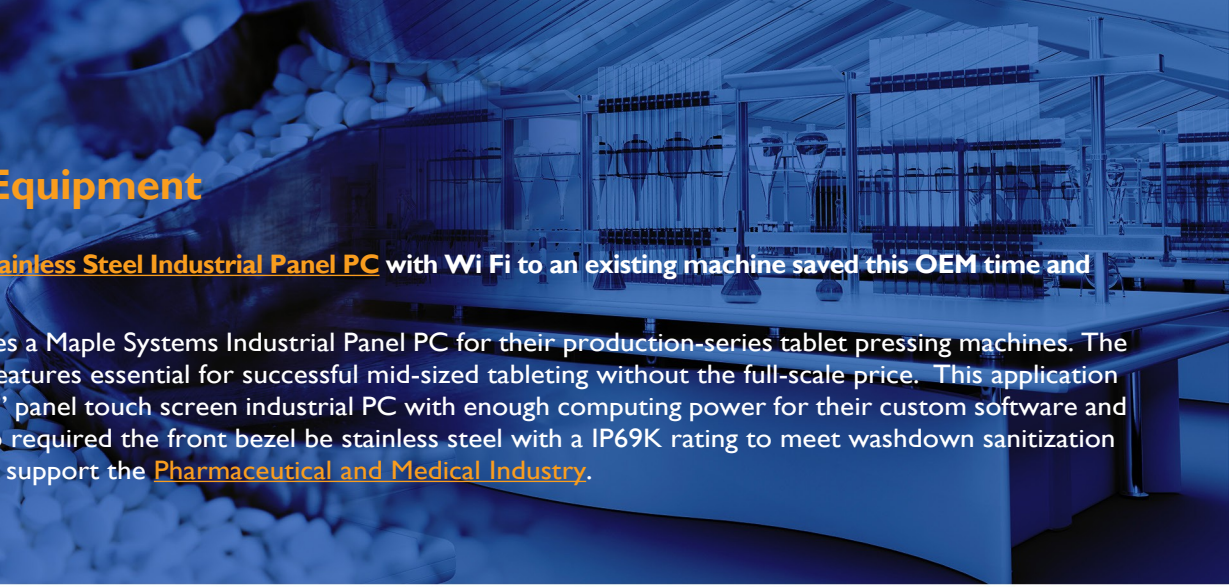

## [Case Study](#)

# Water / Wastewater Treatment

Our [High Brightness Industrial Panel PC](#) with Wi-Fi checked all the boxes for this System Integrator

During their large revamping of a utility control system, Aqua Sierra's customer North Tahoe Utilities needed a PC-based HMI to run a simple Wonderware SCADA project as an interface. The PC needed to allow 3rd party software logging and reporting tools for their utility management system. The control room facility is climate controlled with large windows and bright overhead lighting. The remote facility did not have Ethernet cabling out to the PC location, however there was a Wi-Fi router connection nearby. Read how we support the [Water & Wastewater industry](#).

## [Application Story](#)

# Dairy / Agriculture Equipment

The [Stainless Steel enclosure](#) makes this Industrial Panel PC the right choice for the food and beverage industry

This customer is a leading OEM manufacturer of custom stainless steel processing equipment and a preferred provider of quality products and services to the cheese, dairy, food, beverage and other sanitary industries. The customer's dairy processing equipment required an IPC that operators can interface with while wearing gloves. Another major requirement is that the PC be IP69K washdown rated to endure the regular cleaning and disinfecting required; and for compliance and record keeping, the customer needed real time data logging and storage using a 3rd party historian application running on the PC. Read more about the [Food & Beverage OEMs](#) we support everyday.

